

## About the effect of expansion of reproduced frequency band by electroacoustic transducer

V. Sharapov, M. Musiyenko, Zh. Sotula, L. Kunickaya

Cherkasy State Technological University,  
бул. Шевченко, 460, з. Черкасси, Ukraine,  
E-mail: v\_sharapov@rambler.ru

### Abstract

The article describes the effect of electroacoustic transducer frequency band expansion. The effect appears when a transducer is affected by electric voltage in the form of meander. A noise meter is used to measure the levels of low-frequency and high-frequency sound pressure produced by electroacoustic transducer under the influence of electric voltage in the form of meander. Based on experiments, the levels low-frequency and high-frequency sound pressure rose by 10-20 dB.

**Keywords:** electroacoustic transducer, sound pressure, electric voltage, meander, spectral density, amplitude – frequency characteristic.

### Introduction

Electroacoustic transducers (EAT) are designed to convert electric voltage into acoustic signal and vice versa. They work in a gaseous medium and are widely used in measuring instruments, calculating equipment, domestic appliances and other areas [1-3].

EAT can be based on various physical principles.

There are mechanical, electro-dynamic, magnetostriction, electrostatic, piezoelectric electroacoustic transducers [1]. Nowadays piezoelectric transducers are most widely used.

Bend oscillations in EAT prove to be very efficient since in that case the acoustic impedance of transducers is much lower than with other types of oscillations. Such transducers are characterised by a relatively high coefficient of electroacoustic transformation and they enable to achieve rather high displacement amplitudes.

Bend oscillations can be rather easily excited in asymmetric bimorphous piezoelectric transducers [1, 2].

Fig.1 shows the construction of then electroacoustic transducer EAT-19 (3ИИ-19) (ОАО «Аврора», Volgograd, Russia) with asymmetric bimorphous piezoelements.

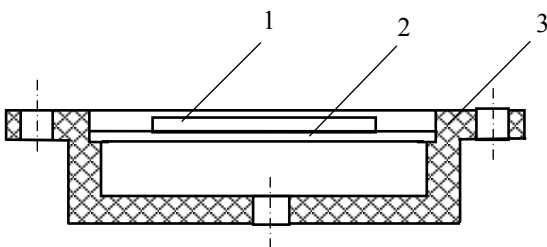

Fig. 1. Electroacoustic transducer EAT-19 ( 3ИИ-19): 1 – disk type piezoelement Ø23×0.2mm; 2 – metal plate Ø32×0.15mm; 3 – polystyrene housing.

Fig.2 shows an equivalent electric circuit of a transducer obtained using the method of electromechanical analogies.

In the diagram the series oscillation circuit  $L_1, C_1, R_1$  corresponds to the bimorphous piezoelement, inductance  $L_2$  represents the mass of air in the space between the housing

and the bimorphous element,  $C_2$  corresponds to air resilience in that space, and  $R_2$  resistance reflects losses when the air passes through the opening.  $C_3$  indicates the static capacity between the piezoelement electrodes.

An equivalent electric circuit of the transducer is shown in Fig.2 [1].

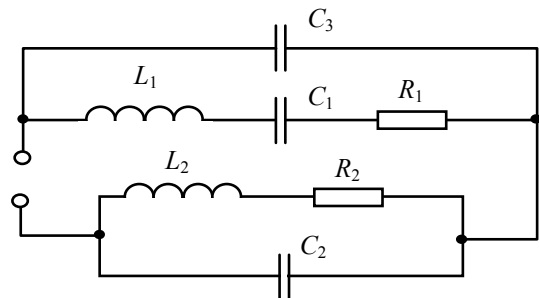

Fig. 2. Equivalent electric diagram of EAT-19 (3ИИ-19) transducer

### Problem and approach

The sensitivity of piezoelectric and electroacoustic transducers depends on the piezoelectric properties of the piezoelement material, the mechanical behavior of the metal plate, the sizes of the piezoelement and the metal plate fixed in the housing and other factors [1-3].

In order to expand the reproduced frequency band, the present work suggests exciting electroacoustic transducers with an electric voltage in the form of meander [4].

A signal in the form of meander (Fig.1) is known [5] and has become common use in a measuring equipment.

Depending on the choice of the reference point, the function can be either odd (for the signal in Fig.3,a) or symmetric (for the signal in Fig.3,b). The Fourier series for the signal in the odd function (Fig.3,a) is given by:

$$s(t) = \dots c_{-1}e^{-i\omega_1 t} + c_0 + c_1 e^{i\omega_1 t} + c_2 e^{-i\omega_2 t} + \dots \quad (1)$$

$$= \sum_{n=-\infty}^{\infty} c_n e^{in\omega_1 t}$$

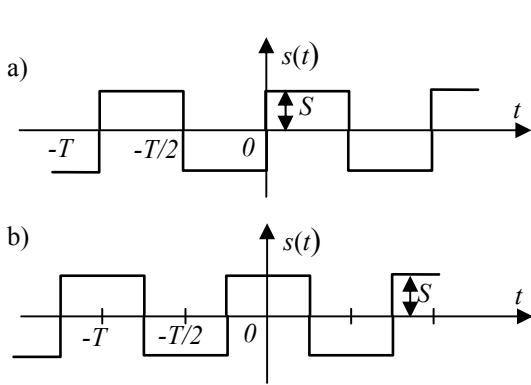

Fig.3. Electric oscillation in the form of meander

where  $c_n = c_{nc} - ic_{ns}$ ,  $c_{nc} = 0$ ,

$$c_{ns} = \frac{2S}{Tn\omega_1} (1 - \cos(n\omega_1 T / 2)).$$

Taking into account  $T\omega_1 = 2\pi$ ,

$$s(t) = \sum_{n=1,3,5,\dots}^{\infty} 2|c_{ns}| \cos(n\omega_1 t - \pi/2) = \frac{4S}{\pi} \left( \sin\omega_1 t + \frac{1}{3} \sin 3\omega_1 t + \frac{1}{5} \sin 5\omega_1 t + \dots \right). \quad (2)$$

For the signal of the symmetric function (Fig.4,b)

$$s(t) = \frac{4S}{\pi} \left( \cos\omega_1 t - \frac{1}{3} \cos 3\omega_1 t + \frac{1}{5} \cos 5\omega_1 t - \dots \right).$$

The Fourier spectral density of the rectangular impulse (Fig.4,a) correspondent to a single impulse of the signal in the symmetric function in the form of meander (Fig.4,b) is defined by the following formula:

$$S_1(\omega) = A \int_{-\tau_H/2}^{\tau_H/2} e^{-i\omega t} dt = \frac{A}{-i\omega} \left( e^{-\frac{i\omega\tau_H}{2}} - e^{\frac{i\omega\tau_H}{2}} \right) = \frac{2A}{\omega} \sin \frac{\omega\tau_H}{2} = A\tau_H \left[ \frac{\sin(\omega\tau_H/2)}{\omega\tau_H/2} \right]. \quad (3)$$

By increasing (decreasing) the pulse duration, the distance between zeros in  $S_1(\omega)$  function decreases (increases) matching the spectrum contraction (expansion), while the value  $S_1(0)$  rises/falls.

Thus, once the period affecting electroacoustic transducers of the signal in the form of a meander changes, the spectrum of the affected signal changes, which leads to changes in the output signal.

While measuring the time from the middle of the impulse (which corresponds the odd function of the signal in the form of meander), it is necessary to take into consideration the pulse shift in the time domain  $\tau_H/2$  in favor of delay.

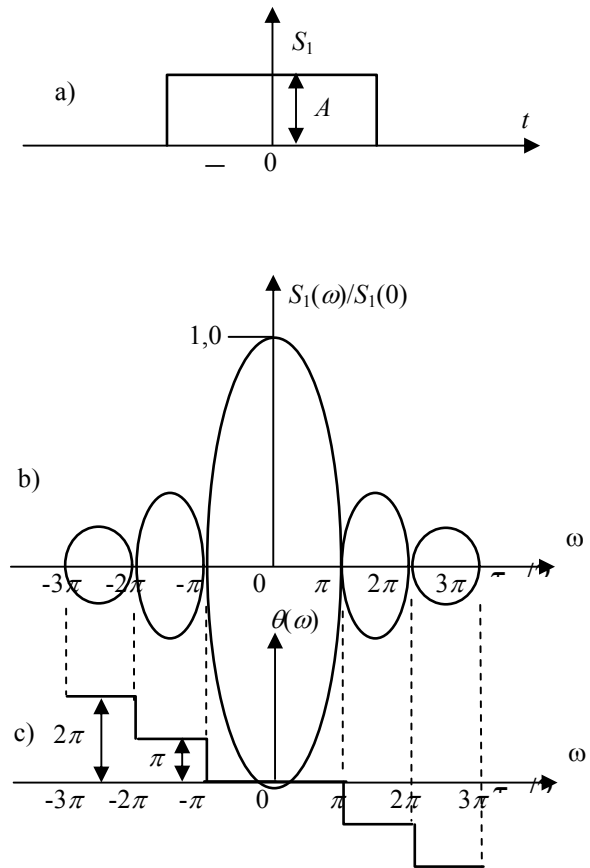

Fig.4. Rectangular impulse: a – form; b – Fourier spectrum density module; c – argument of the Fourier spectrum density (phase-frequency characteristic)

## Results

Amplitude-frequency responses of the transducers EAT-19 (3II-19) were measured according to the sound pressure exciting them by 5V meander in the range of 20-10000 Hz.

The measurements were performed using the system the structural diagram of which is shown in Fig.5.

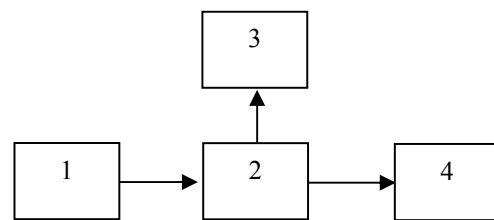

Fig.5. Structural diagram of measuring equipment: 1 – generator Г3-106; 2 – 3II-19; 3 – noise meter RFT00024; 4 – oscilloscope C1-55

Excitation of the electroacoustic transducer by the electric voltage in the form of meander causes irregular shape oscillations (Fig.6)

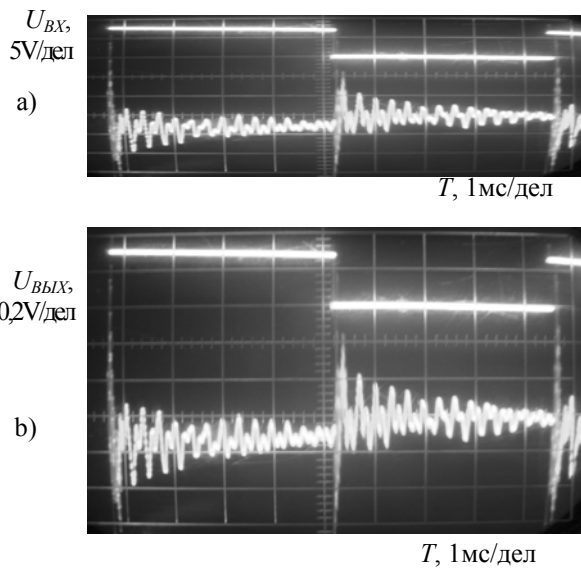

Fig.6. Time waveforms: a – input signal; b – output signal in the transducer EAT-19 (3П-19)

Fig.7 shows the results of measurements of pressure amplitude-frequency responses.

As it is seen from Fig.7, the range of the reproduced frequencies is considerably wider in the area of low (0,02-2,0) kHz and high (6,5-10) kHz frequencies.

Piezoelectric electroacoustic transducers are known to constitute an oscillation system with several resonances [1-3].

Specifically, for the EAT-19 (3П-19):

- 1.2 kHz: resonance originating in the EAT-19 (3П-19) housing;
- 2.8 kHz: resonance of oscillations of bimorphous piezoelement fixed at the generating line;
- 3.7 kHz: resonance of oscillations of unfixed bimorphous piezoelement.

The following resonances are harmonics of the first three ones.

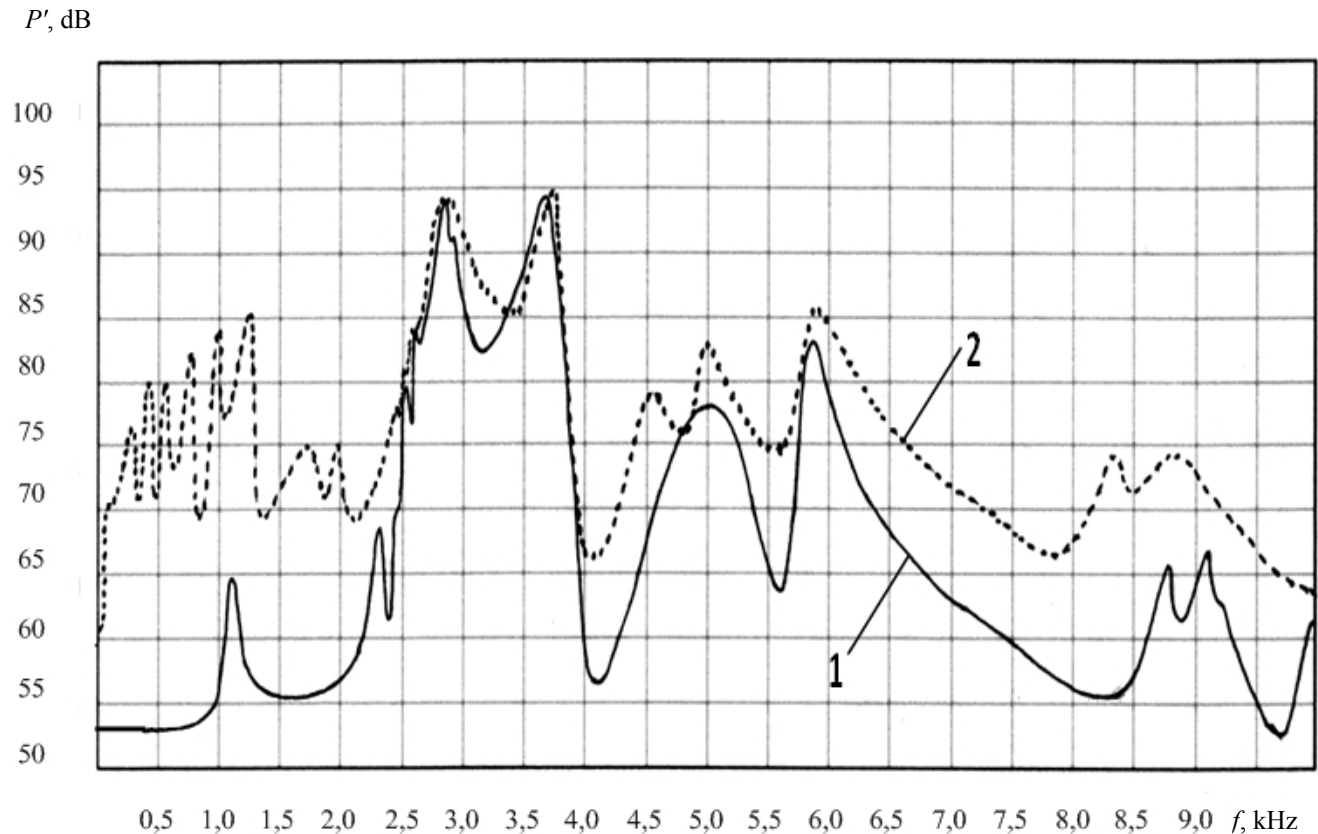

Fig.7. Amplitude-frequency responses of the piezoelectric transducer EAT-19 (3П-19) under excitation by electric voltage in sinusoidal form (curve 1) and meander (curve 2)

## Conclusions

Electroacoustic transducer, when excited by a meander electrical signal, reproduces sounds in a frequency range

where there is no sound under excitation by the sinusoidal voltage.

Interestingly, a listener subjectively perceives the produced sound as a mono-frequency sound corresponding

to the frequency of tracking meander rather than complicated oscillations or “chatter”.

Consequently, there is a real possibility of sound reproduction by means of piezoelectric electroacoustic transducers in a low-frequency range where their sensitivity under excitation by sinusoidal oscillations is close to zero.

The obtained results can not be explained by the change in the spectrum and strength of the exciting signal (meander) since the oscillation system does not change its properties.

#### References

1. **Шарапов В. М., Мусиенко М. П., Шарапова Е. В.** Пьезоэлектрические датчики. М.: Техносфера. 2006. P. 632.
2. **Кажис Р. Й.** Ультразвуковые информационно-измерительные системы. Вильнюс: Мокслас. 1986. P. 216.
3. **Petrauskas A.** Design and the radiation patterns of rectangular symmetric bimorph piezoelectric transducers in cosinusoidal flexural vibration. ISSN 1392-2114 Ultragarsas (Ultrasound). Kaunas: Technologija. 2009. Vol. 64. №1. P. 29-36.
4. **Шарапов В. М. и др.** Патент Украины 22600 МПК (2006) H04R 17/00 опубл. 25.04.07, Бюл. №5. Спосіб збудження коливань п'єзоелектричного електроакустичного перетворювача.
5. **Гоноровский И. С.** Радиотехнические цепи и сигналы: Учебник для вузов. 4-е изд., перераб. и доп. М.: Радио и связь. 1986. P. 512.

V. Sharapov, M. Musiyenko, Zh. Sotula, L. Kunickaya

#### Elektroakustinių keitiklių dažnio juostos praplėtimas

#### Reziumė

Nagrinėjamas elektroakustinio keitiklio juostos praplėtimas formuojant elektrinės įtampos meandrą. Tam tikslui atlikti elektroakustinio keitiklio žemojo ir aukštojo dažnio garso slėgio matavimai atsižvelgiant į nuo elektrinės įtampos meandro formą. Eksperimentuose gauti žemojo ir aukštojo dažnio garso slėgiai padidėjo 10–20 dB.

Pateikta spaudai 2009 09 14

DOI: 10.5755/j01.u.64.3.17112