

Experimental results in ultrasound reflection tomography for nondestructive testing

E.Jasiūnienė, L.Mažeika, R.Šlīteris

Prof. K.Baršauskas Ultrasound Research Center

Kaunas University of Technology

Introduction

Tomography is the cross-sectional imaging of an object. Data are collected illuminating object from many different directions in transmission or reflection mode. Computed tomography imaging is the reconstruction of a cross-section of a test object from its projections [4,7]. This cross-section of the object can be at any location and orientation. Such imaging can be done using different types of energy: ultrasound, electrons, alpha particles, lasers and radar [3,4,7].

The tomographic imaging is more highly detailed than other forms of imaging, because this method reconstructs single selected plane of three dimensional object. In addition, in computed tomography it is possible to use image enhancement algorithms [3]. In conventional methods of imaging a three-dimensional object is displayed in two dimensions, and therefore superposition of features occurs. Then reflective nonhomogeneities from outside of plane of interest are superimposed one on another. This makes detection and characterization of discontinuities more difficult [3,7].

Ultrasonic energy gives the view of the cross-section, not available with other types of energy, because it measures the elastic properties of the material. Mapping of the elastic discontinuities gives different pattern than the mapping of absorption and scattering coefficients. Ultrasonic measurement provides data most closely related to determination of the material under the test properties (nonhomogeneities, their position, shape and size), what is for us of main interest [1,2,7]. Ultrasound tomography can be divided into transmission and reflection tomography. The use of ultrasound tomography for nondestructive testing is different for transmission and reflection modes. Usually the transmission ultrasonic tomography is used for determining variations in a material density, a composition and a residual stress. The reflective ultrasonic tomography usually is used to locate and size discontinuities, erosion, corrosion of metals and to characterize voids and inclusions [3,6].

In ultrasonic tomography the wavelength is comparable to the size of an object nonhomogeneities. Therefore diffraction can occur, and several methods have been introduced for reconstruction of the image, taking into account diffraction effects [4,6-10]. The goal of our work was to investigate, what results it is possible to obtain using the filtered backpropagation algorithm in an ultrasonic non-destructive testing, neglecting the

diffraction effects. Also the effect of the deconvolution was investigated.

Basic Principles of Reflection Tomography

The basic aim of the ultrasonic reflection tomography is to construct a quantitative cross-sectional image displaying a specific ultrasonic parameter of the material under a test from the reflection data. The size and location of the detected discontinuity or material interface can be estimated by the amplitude and the time of flight of the reflected signal [2,3].

One nice aspect of the reflection tomography in comparison with transmission tomography is that it is not necessary to encircle the object with transmitters and receivers for collection of projections data. Transmission and reception of signals are performed by the same transducer [2,4]. However, because most of an ultrasonic energy is scattered in the forward direction, the transducer must have high sensitivity in order to measure backscattered signals at high signal-to-noise ratios [3,5].

Reflection tomography measures line integrals of the object reflectivity function [2,4]. An object is illuminated by a very wide fan-shaped beam. A broad band transducer is used for transmitting and receiving signals [3,5]. The transducer is rotated around the object at a radius R , and its position is indicated by (R, θ) (Fig.1). The transducer transmits and receives pulse signals, reflected from nonhomogeneities. The received signal at the time instant t represents the total of all reflections at the distance d from the transducer:

$$d = \frac{tc}{2}, \quad (1)$$

where c is the ultrasound velocity in the object.

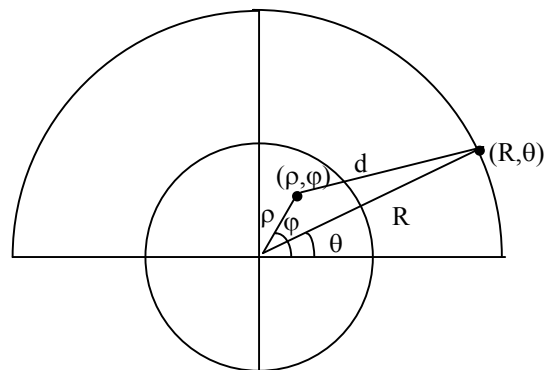

Fig.1. Transducer position is indicated by (R, θ) and the position of the nonhomogeneity by (ρ, ϕ)

In the far field of the transducer distances from the center and the sides of the transducer are almost the same, so we can assume that we are using a point type transducer [4]. The points at the same distance from the transducer are located on the arc, thus reflection tomography measures line integrals over circular arcs. From the received signals the ultrasonic image of nonhomogenities (objects reflectivity function) can be reconstructed [2,4]. Then, by moving the transducer over a sphere wrapped around an object it is possible to collect enough data to reconstruct the entire object.

The recovering of the image in ultrasound reflection tomography is done in two steps [2,4]:

- 1.Collection of the projection data;
- 2.Image reconstruction from projections.

Reconstruction Algorithm

The reflection tomography using point type transducers gives line integrals of the object reflectivity function over circular arcs. One of the methods to reconstruct the reflectivity function of the object under the test is by carrying out a backprojection over circular arcs [4,8,9]. The derivation of the algorithm can be found in [4]. The reconstruction algorithm consists of the 3 steps:

1.The measured data are transformed into the measures of line integrals over circular arcs using formula:

$$y_r(d) = IFT \left[\frac{FT\{y_{sc}(t)\}}{FT\{y_{in}(t)\}} \right] d^{1/2}, \quad (2)$$

where $y_r(d)$ is the estimate for the line integral of the reflection data; $y_{sc}(t)$ is the scattered field measured by the point type transducer; $y_{in}(t)$ is the transmitted signal; $FT\{ \}$ indicates a Fourier transform with respect to t ; $IFT\{ \}$ represents the corresponding inverse Fourier transform, d is the distance between the transducer and the circular arc.

1.The data are filtered with $h(d)$

$$y_{rf}(d) = y_r(d) * h(d), \quad (3)$$

where $h(d)$ is the filter function, and $*$ denotes convolution.

Fourier transform of the filter function can be expressed:

$$H(\omega) = \begin{cases} \omega/(2\pi), & |\omega| < \omega_c \\ 0, & |\omega| \geq \omega_c \end{cases}, \quad (4)$$

where ω_c is cutoff frequency.

2.Backprojection over circular arcs:

$$f(\rho, \varphi) = \frac{1}{2\pi} \int_0^{2\pi} y_{rf} [d(\theta, \rho, \varphi)] d\theta, \quad (5)$$

where the distance from the transducer at (R, θ) to the reconstruction point at (ρ, φ) is given by

$$d(\theta, \rho, \varphi) = \sqrt{R^2 + \rho^2 - 2R\rho \cos(\varphi - \theta)}. \quad (6)$$

For this type of the reconstruction algorithm it is necessary that the Born approximation should hold. This means, that scattered fields must be small compared to incident fields. The absorption and the velocity variations of the field must be also small. The scatterers in the object must be isotropic, so that the field scattered by any point would be identical independently from the direction of the incident field.

Computer Simulation

In order to test the reconstruction algorithm and the validity of the developed programs the computer simulations have been carried out.

We have assumed, that the dimensions of nonhomogenities are smaller then the wavelength. It means that the nonhomeogenities are point type reflectors and the reflection coefficient of the nonhomogeneity is assumed to be equal to 1, that is, the whole incident field is reflected. The influence of the diffraction in the reconstruction algorithm has been neglected. All calculations were made in two dimensional approach.

In order to test the possibilities and the accuracy of the reconstruction algorithm under given assumptions two models, consisting of point type reflectors, spaced at different distances (Fig.2 and Fig.3), were used. We have assumed, that an ultrasound wave was propagating in water having the velocity of ultrasound $c=1480\text{m/s}$, the frequency of the transducer was $f=2.5\text{MHz}$ and the beam divergence angle 45° . We have assumed, that the transducer transmits radio pulse with asymmetrical Gaussian envelope, number of periods of which was 4. Such a signal is very similar to the real signal, generated by the transducer.

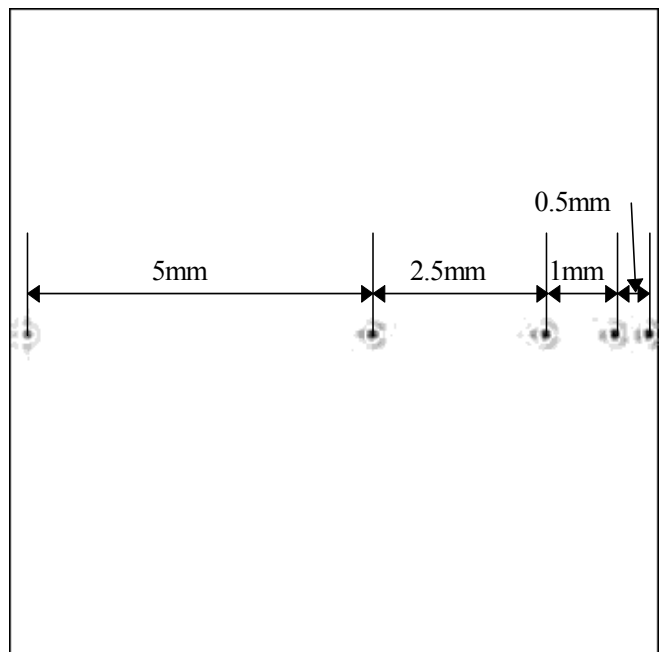

Fig.2. Reconstructed image of 5 point reflectors (simulated experiment)

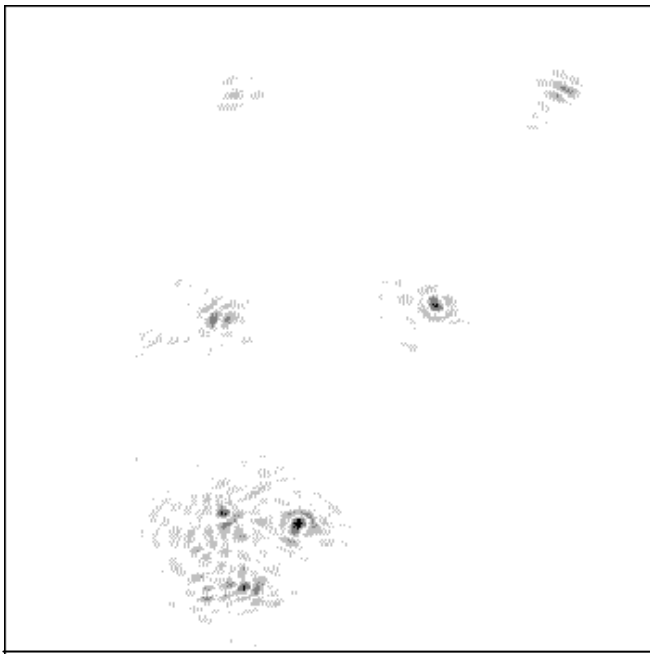

Fig.6. Reconstructed image of 8 point reflectors (simulated experiment)

The wavelength of the transmitted wave $\lambda = c/f = 0.6\text{mm}$.

The object was rotated from 0 to π . 256 projections were calculated, each consisting of 256 sampling points. The reconstructed image consisted of 256×256 points.

The reconstructed images are presented in Fig.2 and 3. From these pictures we can see theoretical possibilities and limitations of the reconstruction algorithm under given assumptions. From the pictures it can be seen, that it is possible to resolve two reflectors, even when distance between them is only $0.5\text{mm} = 0.83\lambda$.

In order to improve the spatial resolution of the images deconvolution was performed. Deconvolution has to reduce the effect of the input signal waveform. Distortions in the images are only due to the fact, that performing deconvolution, when spectrum of the input signal is 0, we have division by 0. It is possible to overcome this problem only by making some assumptions.

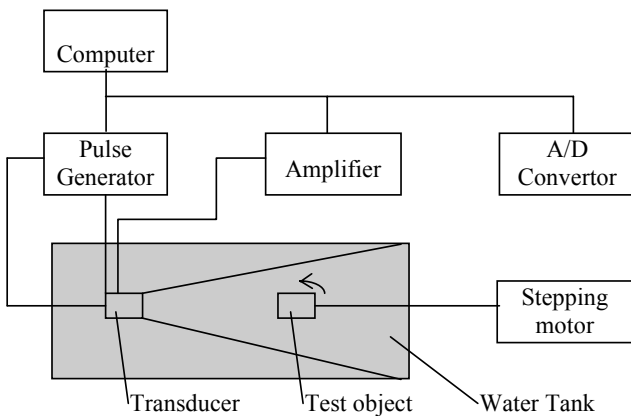

Fig.4. Experimental setup

Experimental Results

Experimental measurements were carried out to confirm the simulation results. The block diagram of experimental set-up is presented in Fig.4. The transducer and the test object were located in the water tank. The frequency of the transducer was $f = 2.5\text{MHz}$, and the beam divergence angle 38° . Experimental measurements were made for two groups of test objects:

1. Three test objects were made from copper wires with diameter 0.5mm , positioned in different way. Two of them were made the same, as for computer simulation. The third was micro chip. These test objects are difficult for imaging, because there are multiple reflections between wires and therefore it is difficult to resolve wires, when they are near or behind one another.

2. Another two test objects were made from the sheet of the copper: the corner and the wavy type reflectors. Objects of such complex structure are also very difficult to image, because of the wave refraction phenomena.

The object was rotated from 0 to π and 105 projections were taken, 256 samples in each. Data acquisition was done using visualization system 'Ultralab-2' [11], which was created in Ultrasound laboratory.

The images reconstructed from experimental data are presented in Figures 5-9. If to compare these reconstructed images with images after computer simulation, we can see, that there are more noise around reflectors, but still for 5 point reflectors (Fig.5) it is possible to resolve two nonhomogenities, when distance between them is $0.5\text{mm} = 0.83\lambda$, like in computer simulation. When there are 4 reflectors at small distances near each other, we can only resolve two reflectors, when the distance between them is $1\text{mm} = 1.67\lambda$ (Fig.6).

The pins of the chip (Fig.7) are well reconstructed only from one side, mainly to the reason that we have taken projections only from half of the circle.

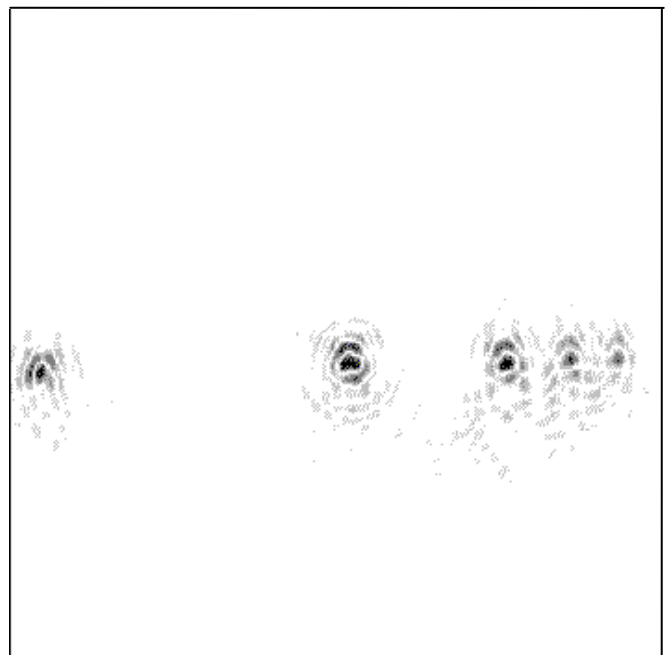

Fig.5. Reconstructed image of 5 point reflectors

In Fig.8 and Fig.9 the reconstructed images of objects, having complex geometry, are presented. It can be seen, that the shape of the corner and the wavy type reflectors were well reconstructed.

The distortions in all reconstructed images are due to multiple reflections, mechanical instability and also due to the fact that we don't know exactly the waveform of the transmitted signal.

Conclusions

The main purpose of this work has been to carry out an experimental verification of the filtered backpropagation algorithm in nondestructive testing. Our results show that, although the influence of the diffraction has been neglected, experimentally it has been established, that quite a good quality of reconstructed images can be obtained. It is possible to resolve nonhomogeneities even when distance between them is only 0.83λ . It is also possible to reconstruct images of objects having complex geometry.

It was proved that using deconvolution it is possible to reduce the influence of the shape of the input signal and the reverberation noise.

Though there are limitations caused by diffraction effects to the use of ultrasonic tomography for nondestructive testing, we have shown, that good quality images of the different objects could be obtained.

References

1. **G.S.Kino**. "Acoustic Imaging for Nondestructive Evaluation" Proc. of the IEEE, vol.67, No.4, pp.510-525. 1979.
2. *Не разрушающий контроль в 5 кн. Интроскопия и автоматизация неразрушающего контроля: Практик. пособие/ В.В.Сухоруков, Э.И.Вайнберг, Р.-Ю.Кажис, А.А.Абакумов; под. ред. В.В.Сухорукова.-М.: Высш. шк., 1993.*
3. *Nondestructive Testing Handbook, 2nd edition, vol.7. Ultrasonic Testing/ Albert S.Birks, Robert E. Green, Paul McIntire.- USA:*

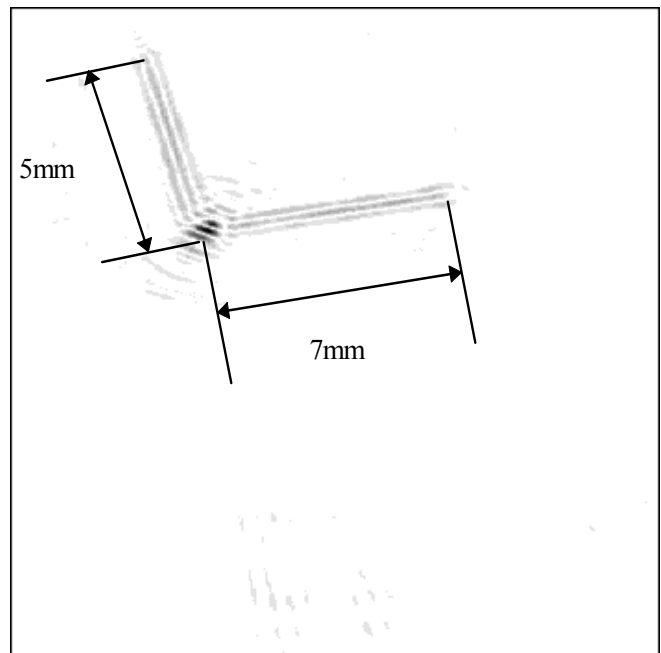

Fig.8. Reconstructed image of the corner

American Society for Nondestructive Testing, 1991.

4. **P.A.C.Kak, M.Stanley**. Principles of Computerized Tomographic Imaging.-New York: IEEE Press, 1988.
5. *Ультразвуковые преобразователи для неразрушающего контроля./ под. ред. И. Н. Ермолова.-М.: Машиностроение, 1986/*
6. **H.W.Jones**. "Recent Activity in Ultrasonic Tomography" Ultrasonics, vol.31, No.5, pp.353-360. 1993.
7. **R.K.Mueller, M.Kaveh and G.Wade**. "Reconstructive Tomography and Applications to Ultrasonics" Proc. of the IEEE, vol.67, No.4, pp.567-587. 1979.

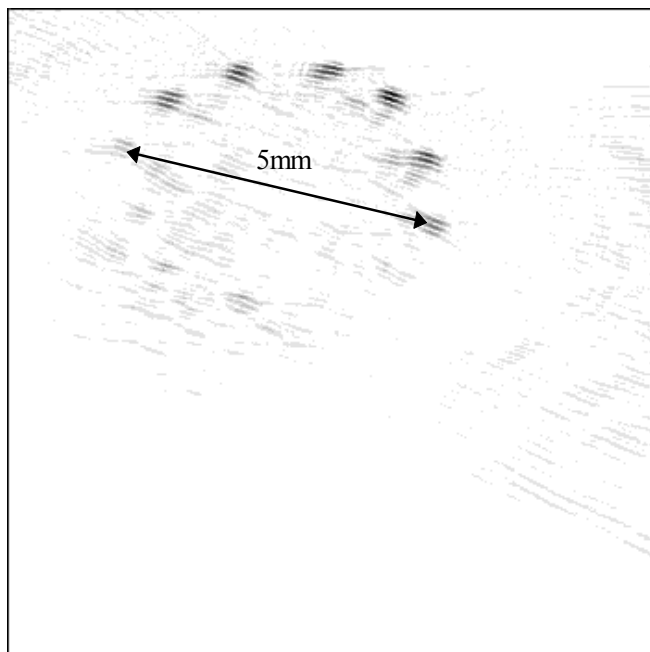

Fig.7. Reconstructed image of the chip

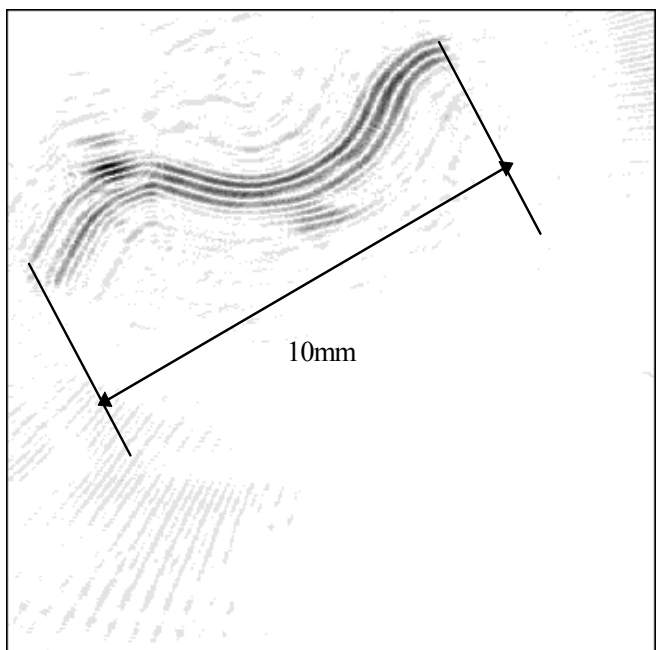

Fig.9. Reconstructed image of the wavy surface

8. **N.Sponheim and I.Johansen.** "Experimental Results in Ultrasonic Tomography Using a Filtered Backpropagation Algorithm" Ultrasonic Imaging, vol.13, pp.56-70 1991.
9. **N.Sponheim, L.-J.Gelius I.Johansen and J.J.Stamnes.** "Quantitative Results in Ultrasonic Tomography of Large Objects Using Line Sources and Curved Detector Arrays" IEEE Trans. on Ultrasonics, Ferroelectrics and Frequency Control, vol.38, No.4, pp.370-379. 1991.
10. **L.Capineri, H.G.Tattersall, J.A.G.Temple and M.G.Silk.** "Time of Flight Diffraction Tomography for NDT Applications" Ultrasonics, vol.30, No.5, pp.275-288. 1992.
11. **V.Dumbrava, R.Kapys, L.Mažeika, L.Svilainis.** "Digital Ultrasonic Imaging System: the Software Concept" Informatica, vol.2, No.4, pp.478-597. 1991.

E.Jasiūnienė, L.Mažeika, R.Šliteris

Ultragarsinės atspindžio tomografijos taikymo neardančioje kontroleje eksperimentiniai rezultatai

Reziumė

Šiame straipsnyje yra pateikti eksperimentiniai rezultatai, gauti taikant ultragarsinę atspindžio tomografiją neardančioje kontroleje. Vaizdų atstatymui buvo naudojamas atvirkštinio projektavimo algoritmas. Kompiuteriniai skaičiavimai ir eksperimentiniai rezultatai parodo, kad net prie priimtų apribojimų, galima atskirti du nevienalytiškumus, kai atstumas tarp jų yra mažesnis už bangos ilgį. Taip pat galima atstatyti formą objektų, turinčių sudėtingą geometriją.

DOI: 10.5755/j01.u.26.1.7826